



Celebrating Our 25th Anniversary!

Volume XXVI, no 9

<http://www.w8lky.org>

September 2012

Serving the Tri-County area since 1986

Table of Contents

August Minutes	3
Calendar	17
Castle Run	15
Contact Us	2
Club Info	2
Club Picnic	15
Dennis, AI8P to speak	4
Fox Hunt Results	15
Fox Hunt Schedule	15
Meeting Announcement	1
Net Info	2
Ohio QSO Party	6
Ohio Section Newsletter Contest	1
OSPOTA	16
Pictures	7
Rambling by KD8MQ	2
Special Event Station	15
Swap & Shop	13
Vanity Callsign fee to increase	5
Wayback Machine	18
Website changes	4

Zero Beat Awarded 3rd Place



Our Next Meeting

will be on Wednesday, September 12th, 2012.

This months speaker, is **Dennis Conklin, AI8P.** He'll be speaking on

"QSLing Tips for Best Return Rates"

At 6 PM on meeting night, please join us for dinner at

Don Panchos Tex-Mex Cafe
2105 W. State St,
Alliance

The Zero Beat has again placed in the Ohio section newsletter Contest.

The Ohio Section Newsletter contest was begun in 1991, by Joe, Phillips, K8QOE (SK). The purpose was to improve the quality of the newsletters in the Ohio Section.

The Ohio Section newsletter contest is not only conducted to reward excellence in our newsletters but to reward growth and im-

provement among all participants.

This years award was presented at the Ohio Section Convention, in Columbus.

First place went to the Radiogram, from PCARS. The editor is Tom, KB8UUZ.

Second place went to the Feedback, from the Massillon ARC. the editor is Gary, WC8W.

Congratulations to all.

Officers

President

KD8MQ
John Myers
910 West Mill St.
Alliance, OH 44601
kd8mq@neo.rr.com
330-936-5021

Vice-President

K8DXR
Howard Miller
10626 Dot Ave.
Alliance, OH 44601
hmliller32@neo.rr.com
330-821-9392

Secretary

AB8KV
Donald R Kingan
446 West High St.
Alliance, OH 44601
dkingan@neo.rr.com
330-821-5819

Treasurer

KB8IVS
Mary Ann Royer
6255 Sandalwood NE
Canton, OH 44721
kb8ivs@aol.com
330-492-0703

Trustees

WA8WHP
Frank Sanor
2142 Blenheim Ave
Alliance, OH 44601
wa8whp@juno.com
330-206-2639

KD8BBK
Tony Shillig
8980 Paris Ave
Louisville, OH 44641
kd8bbk@aol.com
330-875-0085

KD8KMQ
Ben Davis
4561 Anderson Ave, NE
Homeworth, OH 44634

Editor

John Myers, KD8MQ
(See above)

Rambling

By John, KD8MQ

Welcome to the September issue of the Zero Beat. It's a big one this month, as I catch up on some of the pictures I've not had time for in previous editions.

A very small portion of this newsletter was done in advance. But, I have to confess that the large part of this is being done over the long Labor Day weekend.

Every month, I promise myself that I'll get things together in advance, so I don't have to work quite so frantically at the last minute.

Then, each month turns out the same. I guess it's human nature.

Newsletter award

We've done it again; the Zero Beat has again placed favorably in the Ohio Section Newsletter Contest. I got an e-mail from Frank, KI8GW; our ARRL Section Manager informing me of the award.

He was, of course close-lipped about how we placed. No doubt, you now know that we came in 3rd.

How far we've come

In preparing this issue of the Zero Beat, I noted that the September 2007 minutes took up a whopping half page. That's in contrast to today's full page, or more versions of the minutes.

I've had several of you tell me, recently, how much more this club is doing lately. I guess this is one way of

(Continued on page 5)

Meetings

The Alliance Amateur Radio Club meets on the Second Wednesday of each month. Check the meeting announcement on page 1, for the location. Talk-in is on 145.37 ®.

Meetings begin at 7:30 PM. Visitors are always welcome.

Nets

Thursday is our "net night," with the following nets held:

Ten meters

CW @ 8PM on 28.100 MHz
SSB @ 8:30PM on 28.400 MHz

2 meters

9 PM on 145.37 MHz

The Homeland security Net meets on the last Tuesday of the month, at 8:00 PM, on 147.51 simplex

Internet

Web: www.w8lky.org

E-mail: W8lky@w8lky.org

We are also on Facebook!

Newsletter Information

The Zero Beat is a publication of the
Alliance Amateur Radio Club
P.O. Box 3344
Alliance, OH 44601

Unless otherwise noted, permission is granted to reprint portions of the Zero Beat, as long as credit is given to the author & source.

You can submit material to the Zero Beat via e-mail to kd8mq1@gmail.com

August Minutes

August 8, 2012

The regular meeting of the Alliance Amateur Radio Club was held on August 8, 2012 at 7:30 PM in the first floor conference room of the Alliance Community Hospital with club President John Myers (KD8MQ) presiding. The pledge of allegiance was recited followed by introductions. There were 21 members present along with Miriam Sanor and guests Mike Taylor, Steve Simon, Chris Jester, Brenton Sears, Bruce Maendel, Frank Piper (KI8GW) and John Tucker.

President John then introduced Frank Piper, our Ohio section manager, as the speaker for the evening and allowed him to give his presentation first due to the distance he had to travel home. Frank then spoke to the club about, among other subjects, the recent passage of the Ohio bill addressing antenna restrictions, the importance of active local clubs, activities at ARRL headquarters and notes about the upcoming convention in Columbus.

Returning to the club business meeting, President John announced birthdays for the month which included:

- Peter (N8IGZ)
- Tomas (KC8ZEH)
- Rev. Dave (N8NLZ)
- VP Howard (K8DXR)
- Duane (W8DHZ).

Secretary Don

(AB8KV) gave the Secretary's report, noting that the July meeting minutes were in the newsletter. He added that the final special event announcement was now in QRZ.

He then passed around a flyer concerning a fundraising event for Tyler Schillig. With nothing further, the report was approved on a motion by Frank (WA8WHP) and seconded by Tom (KD8JRK).

Treasurer Mary Ann (KB8IVS) then gave the Treasurer's report. The report was approved on a motion by Smitty (KC8TJQ) and seconded by Tom.

Committee reports:

- Regarding ARES and nets, Don (K8OMO) had no report on the Homeland Security net as the recent fox-hunt was necessarily scheduled on the same night.

- John then passed around a flyer for a separate benefit dinner for the Schillig family.

Old business:

- John announced the top operator awards for Field Day: First place went to Duane (W8DHZ), second to Don (K8OMO) and third to Frank (WA8WHP).

- John then reminded the club about the special event station on August 18 and the Ohio QSO party on August 25.

- He also addressed the questions of the location

and date for the club picnic. After some discussion, it was decided to hold the picnic on September 29 with the discussion regarding location tabled until the next meeting.

- Frank then gave a report on the meeting held by the trustees regarding forming a repeater committee. A proposed addition to the by-laws detailing the make-up of the committee and its responsibilities was read out. Don (K8OMO) commented that the information should not be put into the newsletter as it is the club's private business with the newsletter being a public forum. John agreed and it was decided to email it to the individual members for their consideration, with voting on the addition to occur at the September meeting.

- President John then reported on the club's acquisitions from the K8LTG auction, noting that an anonymous benefactor had contributed monies to help the club acquire items it needed. The items actually obtained included:

- A Rohn-25 tower, consisting of 1-10' top section, 1-10' base section with a tilt-over base plate, 5-10' center sections

- The Hazer unit (no rotor or top bearing) and 60-70 feet of rotor cable.

- A 40-foot push-up mast using 1.25" tubing.

(Continued on page 4)

August Minutes—cont.

(Continued from page 3)

- A complete 10-meter, 3-element beam antenna.
- A 6-meter, 6-element beam antenna (no boom included).
- A complete Mosley TA-33.
- An 8-element, 440 MHz beam antenna.
- Approximately 80-feet of ½" hardline with N connectors.

Although no rotator was included, John announced that Dave (N8NLZ) had donated an HD-73 rotator and control box to the club which would fill that gap.

John then asked the Secretary to forward a thank-you card to Dave for his generous donation.

New business:

John noted that he

wanted to organize a work party in September or October to erect the Rohn tower with the Hazer unit, an antenna and the rotator as a preparatory exercise for next year's Field Day.

John then addressed the question of the club Christmas party date and location. After a brief discussion, Don (K8OMO) stated that he would talk to Panchos about a reservation for the second Saturday in December.

John reminded the club about the Castle Run on Labor Day, for which communications help was needed. He passed around a sign-up sheet for those interested.

---Don (K8OMO) noted that he needed help to remove antennas in Louisville and install new coax

on the repeater.

---John reminded the club about the Columbus hamfest on August 11.

---Smitty brought up the fact that Ben (KD8KMQ) had recently upgraded, for which the club gave him a round of applause.

---Mike Taylor spoke about five power inverters he had brought for the club's potential use and which could be inspected after the meeting.

With no further club business to discuss, the meeting was adjourned at 8:50 PM on a motion by Smitty, seconded by Frank.

Minutes respectfully submitted by Don (AB8KV), Secretary.

Dennis, AI8P To Speak At September AARC Meeting

Our September meeting welcomes back a familiar face. Dennis Conklin, AI8P will speak on "**QSLing Tips for Best Return Rates**".

Dennis most recently spoke to our club last September, on the subject of Antenna Modeling.

Dennis is one busy individual, so I feel fortunate to get him. He is the EC for summit county ARES, as well as an active DXer, and member of the KP2D Virgin Is-

lands ARC contest team.

Our September meeting will be on Wednesday, the 12th, at 7:30. As usual, we are meeting in the Café Conference room at Alliance Community Hospital.

The "Board Meeting", or dinner meeting will be held at Don Panchos, on W. State St, at 6 PM.

Hopefully, we'll see you there!

W8LKY.org To Undergo Some Changes

According to the internet archive, the Alliance ARC has had a web presence since early 1999.

But, times change. It's time for a major re-write of the site. This will allow us to more quickly post news of interest to hams in the tri-county area.

We'll be discussing these changes at the next club meeting.

Rambling - cont.

(Continued from page 2)

measuring that.

Ohio QSO Party

I don't know about the rest of you, but I had fun! The clubs Ohio QSO Party effort wasn't exceptionally well attended, but we managed to do a couple hundred QSOs, consume a lot of pizza, and chips, and do a lot of socializing.

Special Event Operation

We set up at the Jaycee pavilion. This year, rather than bringing the grill, I opted to bring pizza. No one complained.

Classes

As you'll read elsewhere in the newsletter, There will be no classes this fall. Chalk it up to two things; failure to find adequate class space close to Alliance, and my unwillingness to add anything more to my weekly schedule.

The sad truth is that I just have way too many tasks on my to-do list right now. Some are quick & easy to handle and can be knocked out in an hour, or two. Others, will take a bit longer. I've been putting a couple of them off for so darned long that I'm ashamed to think of them.

But, the end result is that there's no classes this year.

Club picnic

There was talk at the

last club meeting of a member stepping up to host the club picnic this year. That didn't happen, so We will be back at the Rustic pavilion in Silver park. I tried for the log cabin, but it was booked.

The date for the club picnic is Saturday, September 29th. There'll be more info elsewhere in this issue.

Club programs

The club program schedule is in decent shape for the incoming president. We have activities, and programs planned through December for sure, and January, if things pan out the way I hope they will.

Elections

Lastly, it's time for the trustees to begin putting together a slate of officers for the October elections. If you'd like to run for an office, please get in touch with one of the club trustees. Let's try to make their job a bit easier this year. That being said, I can guarantee that I will not be running for president this year. After 3 terms, it's time to take a break.

That's all I have for this month. I hope to see you at the next club meeting. 73, de John, KD8MQ.

Wayback Machine - cont.

(Continued from page 18)

- We included a list of 2 Meter nets in the area.
- We also included a net format for the 2 Meter net
- Lastly, there was a story on the upcoming Pa QSO Party.

September, 2007 (editor, KD8MQ)

- We were looking for operators for the 2007 Rotary Castle Run.
- Our club picnic was scheduled for September 29th, at the Silver Park cabin.
- Re the 2007 Field Day entry, our total claimed score was 3800 points.

We made 496 CW QSOs, compared to 383 on phone

FCC Vanity Call-sign Fee Has Increased

Effective September 4th, the cost of a Vanity call-sign has increased from \$14.20, to \$15.

This fee is payable not only when applying for, but also when renewing a vanity call-sign.

The fee has fluctuated from a low of \$11.70, to a high of \$70.

Alliance ARC Activates Mahoning County For The Ohio QSO Party

For the 2nd year in a row, Mahoning county was a significantly easier catch during the Ohio QSO Party.

Held each year on the 4th Saturday in August, the object of the Ohio QSO Party is to contact as many Ohio stations as possible during a 12 hour period. The object, however, for Ohio stations is to contact as many stations as possible. So, those Ohio stations in rare counties sometimes find themselves working pile-ups. Pretty cool, huh?

Members of the Alliance ARC set up two stations in the pavilion at the Sebring Campgrounds.

We operated pretty much the full 12 hours of the contest, and made 195 QSOs, for a claimed score of just over 16,000 points.

All told, I don't think anyone went away unhappy.

Summary:

Band	CW	Qs	Ph	Qs
80:		5		55
40:		11		105
20:		0		18
15:		0		1
10:		0		0

Total:		16		179
		CW Mults = 13		
		Ph Mults = 63		
		Total Score = 16,036		



K8OMO won the first door prize at the AARC site for the Ohio QSO party. Better hurry out and you could be next!



Man, the mosquitoes are huge out here. Fortunately, Rick is on the job...

AARC Picture pages

All summer long, you've been sending me pictures, and I keep putting them off. So, I thought we'd empty out the photo bucket this month.

Get used to it. I plan to run a lot more pictures after October.

Thanks to all of you for your patience.



Remember the Ch 17 tower in Louisville? This is what was left after they torched it. Luckily, they were able to drop it with no harm to people, or Property.
TNX to K80MO for the picture



Here's some shots of the 145.37 Club Repeater
TNX to K80MO for the picture



AARC Picture pages



Here's Steve's (KB8RFE) 2 Meter 6 element and 6 meter 4 element beams, homebrew 2meter on 1 " sq. boom, 6 meter from a 4 element maco 11 meter beam 2" round boom. He sent these picture in May.



AAAHHHH!!!!
Ben's Air Chair was a hit at Field Day!



The student, and the teacher
Mary, KD8RFZ, and Frank, WA8WHP

G1208

THE SHRINKING INCREASING RADIO

50 years ago, Transmitters and Receivers helped to keep the amateur radio shack warm on a winter night and could take up much real estate as shown in the [Operating an Amateur Radio Station 1963 publication by the ARRL](#). Even a modest station (transmitter and receiver) would consist of 2 desk units of the size shown in the picture.

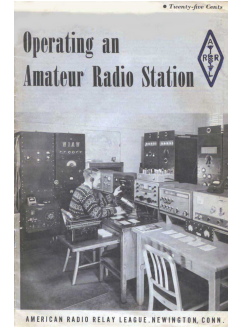

40 years ago, the last of the vacuum tube radios were disappearing from the market. An example is the Heathkit model SB-102. It consisted of all vacuum tubes except the VFO which incorporated a temperature compensated stable solid state circuitry. While this radio was primarily a 120 VAC unit, there was a 12 volt power supply available. Radio Size: 14.75 W, 6.75 H, 13.5 D. AC Power Supply was separate.



30 years ago, the transceivers were a combination of digital and analog VFO's. Shown is the Kenwood TS-130 series, operating from a 12 volt power supply which made for easier HF mobile operation. Radio Size: 9.6 W, 3.8 H, 11.7 D. Power Supply was separate, 120VAC to 12 VDC 20A.



20 years ago, digital readout transceivers were common. Microprocessors were incorporated. Multi-contact mechanical switches were replaced with push button single contact switches. Digital circuitry would then do the necessary control and switching. The Kenwood TS-440 transceiver is an example of this type of design. Radio Size: 10.5 W, 3.5 H, 12 D. Power Supply was separate, 120 VAC to 12 VDC 20A.



10 years ago, multiple processors and digital signal processing was changing the standards. While common size transceivers for desktop radios were available, surface mount components made possible the smaller portable-mobile radio. Radio Size: IC706MKII is 6.5 W, 2.25 H, 7.5 D. Power Supply can be automobile battery, portable power, or 120 VAC to 12 VDC 20A.



Today, specialized chips and multiple processors continue to add features. **The operation and setup of the modern transceiver is many-levels-of-software-choices.** Keeping the manual close to the radio for setup information is the norm. Except for the frequency readout, the LCD Color displays require, at times, magnification to see the wording. That is where the manual and a larger display are needed. In one example, some of the IC7000 functions are programmed using a microphone with 25 push-button-switches. Newer radio examples are shown below.



IC7000



FT-950



K3



OMNI VII

There are also software defined radios that need a computer. All functions are programmed through the computer and displayed on the LCD monitor screen.

Back to the Title:

While the radio size is Shrinking the features are Increasing.

In keeping with this history article, from the pages of the 1970 ARRL publication “LEARNING the Radiotelegraph CODE” the transition from Vacuum Tubes to Solid State is again shown.

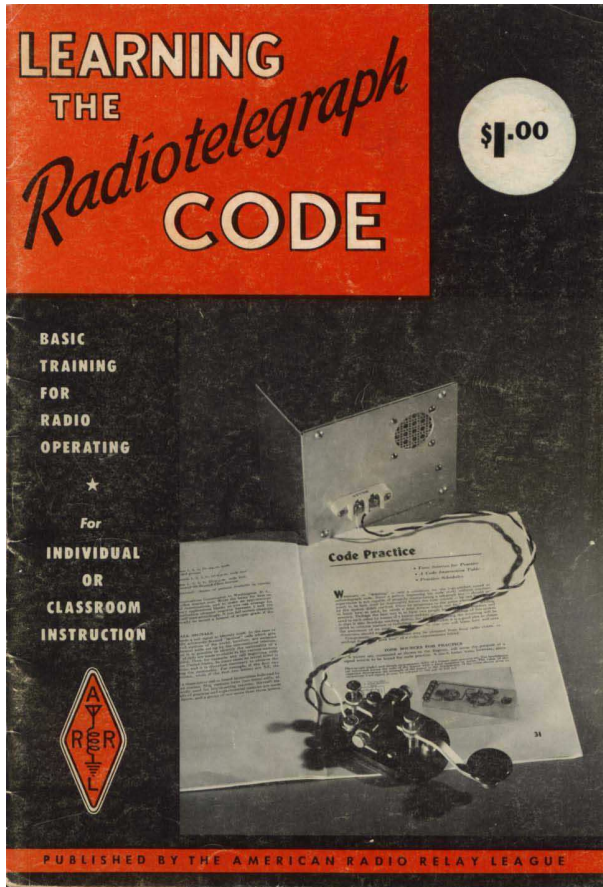

This cartoon shows history can be the same as today !

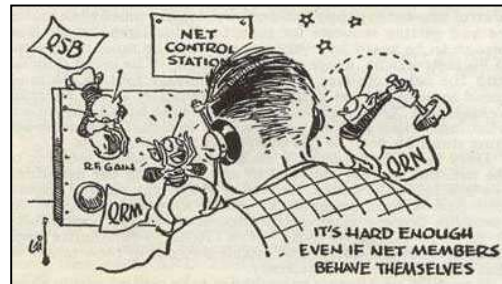

Even with modern radios, frequency checks are important. Are you operating on the right frequency ?



The Vacuum-Tube Code Practice Oscillator, wiring, and schematic.

Note the cleanliness of the layout and right angle wiring. Skill in metal work was a must in those days. Hardware was basic. Now, many choices are available in good looking hardware as well as professional lettering.

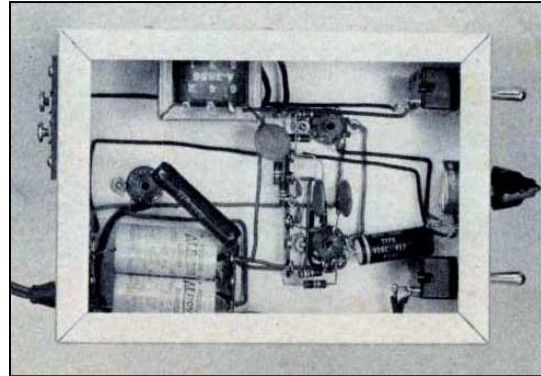
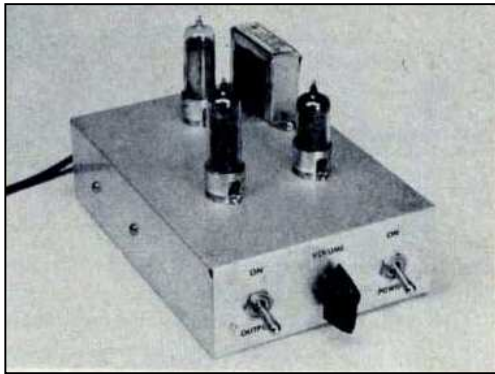

The vacuum-tubes were of typical type in the 1960's. The 35W4 is a diode rectifier similar to the modern day 1N4007. The vacuum-tubes were the same as found in an AM table radio of the 1950's and 1960's. The filaments were in series so the required voltage adds up to 97 volts. The series resistor drops the voltage from 115 volts to the required 97 volts. Short cuts in those days eliminated the power transformer. Note also that there is no chassis ground since the absence of the power transformer causes this circuitry to be at power line potential because the 115 VAC power line is not isolated. For safety, the audio output and keying line is isolated by the audio transformer.

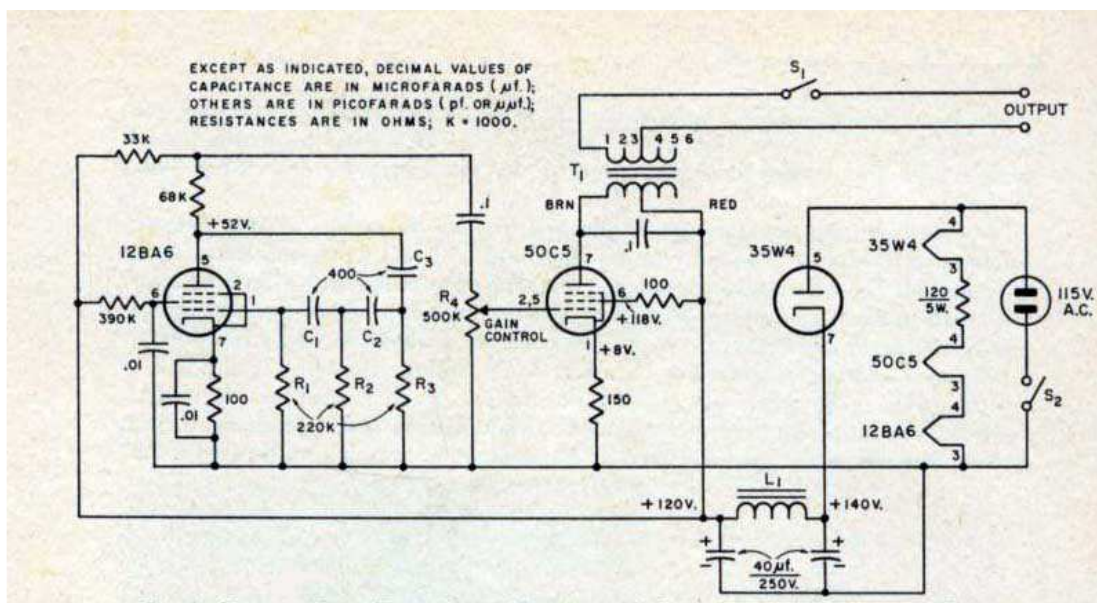

Solid-State Circuitry as described in the ARRL publication.

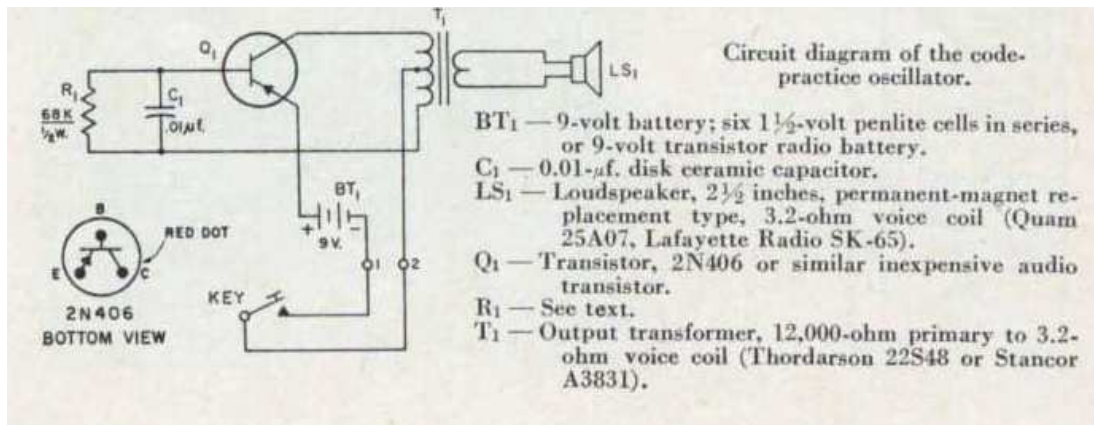

In the 1970's, many times this type of circuit was built into a metal enclosure or some minimal count circuits as shown above were built into reused plastic enclosures with parts glued to the case. A few years later, items were available for the fabrication of custom printed circuits at home.

A Canning Project Costing Only Peanuts !

The WA8MKH peanut-can, morse code, solid-state-oscillator is another choice available in chassis and enclosure. Volume, Tone Control, and LED Light are included. Speaker is glued to the bottom of the can. Circuit is powered by a 9V battery which is disconnected when the key is unplugged.



CW goes high-tech with the home-built Keyer:

Left, a 1960's Vacuum-Tube Keyer built by WA8MKH.
Right, a 1990's Solid-State Version built by WA8MKH's son, Stephen, KC8IDJ.



The history is obvious. Today, solid-state, modern hardware, and a professional lettering printer make a difference in presentation. Solid-state circuitry is lower in cost, less power consumption, and can be portable.



**If Tube-B or not Tube-B is the question,
then Solid-State is the answer !**

73, DE MIKE, WA8MKH

AARC Swap n Shop!

Tim, K8TBS is helping a widow of a SK to liquidate her OM's estate. Here's a updated list.

- 1.) Kenwood TS 450S (no antenna tuner) w/power cord, hand mic. and manual.**
- 2.) SGC Model SG-237 smart tuner (antenna tuner) with manual.**
- 3.) Kantronics Kam Plus Packet Modem with manual.**
- 4.) SCS PTC-LLE Multimode Pactor Controller with manual.**
- 5.) Sony/Tektronix Model 336 50mhz Oscilloscope with operation/service manual.**
- 6.) ProTek Model P-3502C 20mhz Oscilloscope with manual.**

Please contact Tim (K8TBS) on behalf of the widow at this e-mail: tim-sieg@sbcglobal.net

WANTED: 2 meter/ 440 Beam Antenna

contact WA8SHP [330 821 8794](tel:3308218794). wa8shp@aol.com or the W8LKY Repeater

**Just think, your swap & shop items could be here!
You could make money, and clean out the shack! Your XYL/OM/Significant other will
be shocked, amazed, overcome!**

All it takes is a simple e-mail to get the ball rolling. Just let me know

A) what you have, or what you need

B) How much you want for it

C) How to reach you.

That's all there is to it!

Swap & Shop rules: We'll keep the rules simple.

1. All ads will run for two months, unless you contact me to cancel, or extend it.
2. You are allowed to post anything as long as it is Ham Radio, or Computer related.
3. Please, no CB equipment.

To place an ad: contact John, KD8MQ (e-mail: kd8mq@arrl.net)

Ham of the Year ballots are due



Now's the time to cast your vote for the 2012 Ham of the Year.

Get your ballot to Don, AB8KV ASAP! His contact info is on page two.

(dkingan@neo.rr.com)

PREVIOUS HAMS OF THE YEAR

1989	Jim Ferguson	N8DZA
1990	Dave Buckwalter	KC3CL
1991	Jack Bennett	W8WEN (SK)
1992	John Myers	WX8G
1993	Pam Myers	N8IAK
1994	Larry Ashburn	KE8VE (SK)
1995	Gladys Wilson	KB8GIA
1996	Don Whitaker	K8OMO
1997	James W. Wilson	KB8GHZ (SK)
1998	Mary Ann Royer	KB8IVS
1999	David Glass	W8UKQ (SK)
2000	Jerry Wheeler	KG8RN
2001	Robert L. Steele	K8RLS (SK)
2002	Samuel Eberling	KC8ETZ
2003	Joe Young	KC8TAC
2004	George Proudfoot	K3GP
2005	David Glass	W8UKQ (SK)
2006	Franklin A. Sanor	WA8WHP
2007	Howard Miller	K8DXR
2008	John Myers	KD8MQ
2009	Larry Ashburn	KE8VE (SK)
2010	Tony Schilling	KD8BBK
2011	Don Kingan	AB8KV

My vote for Ham of the Year is: _____

Comments (optional) _____

Castle Run wrap-up

Again, a group of local Hams volunteered their holiday morning to give back to the community.

The 5th annual Castle Run was held on Labor Day morning. We handled communications for the 10k race.

We tracked the lead, and the tail of the pack, as well as monitoring critical intersections.

AARC Special Event station

This years Special Event Station went off without a hitch. August 18th dawned bright, and clear. You just couldn't ask for better weather.

We set up two HF stations, in addition to the VHF check-in station. Hours of operation were 10AM - 5PM.

There's no word yet concerning how many contacts we made, what modes

were used, or how many Certificate requests have been received.

Come to the next club meeting, and perhaps all these questions, and more will be answered.

I do know that the pizza was good, and everyone seemed to be having fun.

Upcoming Fox Hunts

<u>Date</u>	<u>Start Time</u>	<u>Hunt/Talk-in Freq</u>	<u>Sponsor</u>	<u>Start Line</u>
September 5 th	6:30 PM	147.525	Cuyahoga Falls ARC	2850 Church St, Stow, Ohio
September 22nd	6:30 PM	147.525	Alliance ARC	1906 S. Union Ave, Alliance
September 19 th	6:30 PM	147.525	Cuyahoga Falls ARC	2850 Church St, Stow, Ohio

For changes, or additions, e-mail kd8mq@arrl.net

Fox Hunt News

I've not got a lot of fox hunt news to report this month. OMO is working on his Doppler, trying to get it to 100%. It's getting close.

At one of the Cuyahoga Falls hunts, OMO, and I had to split up temporarily. Gay was hiding behind Walls School, in Kent. The Doppler was leading us closer, and closer to her hiding spot, but our unfamiliarity with the area was working against us.

We turned up a dead end street, expecting Gay to be parked at the end. At the end of the street, we spied her hiding place, but, unfortunately, it was still about 200 ft away, past a barricade, and across a playground.

So, OMO continued finished the hunt on foot, while I drove to the parking lot via the "official" roadway.

When the results were posted, Our maneuver was good for 2nd, & 4th place in that hunt.

On the Last hunt of

August, Gay took pity on us, and considered the high cost of fuel when choosing her hiding place. She was in Veterans Park, in Hudson. Had more recent maps been loaded into my GPS, the finish would have been different, I promise!

But, it's all good! The CFARC hunts always end the same; a good dinner, at a nearby restaurant, with good friends, and conversation.

I wasn't able to attend the AARC fox hunt in August. But, I understand that Ben was hiding behind the Alliance middle School. Most found him in short order. One hunter had issues with an errant cell tower, but we won't mention their name here.

As always, I welcome any foxhunt related news. I'd like to add your Northeast Ohio fox hunt to our calendar. Just e-mail me the info, or submit it via the form on www.neofoxhunting.org.

Club Picnic

This year's club picnic will again be at the Rustic Shelter in Silver Park. The picnic is scheduled for Saturday, September 29th, at 1 PM.

As usual, meat will be provided. Everyone is asked to bring a covered dish to share.

In addition, we need volunteers to bring the following:

- Pop & Water
- Hot Dog, & Hamburger Buns
- Tableware, and condiments

If you can help with any of this, please notify John, KD8MQ, at 330-936-5021.

The Rustic Shelter is near the sound stage, in the lower part of Silver Park. Come in the main entrance, turn right after crossing the bridge by the lake, and go all the way to the end of the drive. If you get lost, give a call on the 5.37 repeater.

We hope to see you there!

The Portage County Amateur Radio Service, Inc. (PCARS)
announces the 5th annual

Ohio State Parks On The Air



Ohio State Parks On The Air contest

Saturday, September 8, 2012, from 1600 UTC to 2400 UTC

There are **75** Ohio State Parks
Make a day of it and join us in the **FUN!**

Visit a beautiful Ohio State Park
and have some
Amateur Radio Fun at the same time!



Rules? Entry Forms? Log Sheets? Ohio State Park Information?

Check out **all** the details at: <http://parks.portcars.org>

While you're at it, check out the PCARS web site at: www.portcars.org

12 April 2012

September 2012

Sunday	Monday	Tuesday	Wednesday	Thursday	Friday	Saturday																																																																																																		
		<table border="1" style="margin: auto; border-collapse: collapse;"> <tr><th colspan="7">Aug 2012</th></tr> <tr><th>S</th><th>M</th><th>T</th><th>W</th><th>T</th><th>F</th><th>S</th></tr> <tr><td></td><td></td><td>1</td><td>2</td><td>3</td><td>4</td><td></td></tr> <tr><td>5</td><td>6</td><td>7</td><td>8</td><td>9</td><td>10</td><td>11</td></tr> <tr><td>12</td><td>13</td><td>14</td><td>15</td><td>16</td><td>17</td><td>18</td></tr> <tr><td>19</td><td>20</td><td>21</td><td>22</td><td>23</td><td>24</td><td>25</td></tr> <tr><td>26</td><td>27</td><td>28</td><td>29</td><td>30</td><td>31</td><td></td></tr> </table>	Aug 2012							S	M	T	W	T	F	S			1	2	3	4		5	6	7	8	9	10	11	12	13	14	15	16	17	18	19	20	21	22	23	24	25	26	27	28	29	30	31		<table border="1" style="margin: auto; border-collapse: collapse;"> <tr><th colspan="7">Oct 2012</th></tr> <tr><th>S</th><th>M</th><th>T</th><th>W</th><th>T</th><th>F</th><th>S</th></tr> <tr><td></td><td></td><td></td><td></td><td></td><td></td><td></td></tr> <tr><td>7</td><td>8</td><td>9</td><td>10</td><td>11</td><td>12</td><td>13</td></tr> <tr><td>14</td><td>15</td><td>16</td><td>17</td><td>18</td><td>19</td><td>20</td></tr> <tr><td>21</td><td>22</td><td>23</td><td>24</td><td>25</td><td>26</td><td>27</td></tr> <tr><td>28</td><td>29</td><td>30</td><td>31</td><td></td><td></td><td></td></tr> </table>	Oct 2012							S	M	T	W	T	F	S								7	8	9	10	11	12	13	14	15	16	17	18	19	20	21	22	23	24	25	26	27	28	29	30	31						<i>1</i>
Aug 2012																																																																																																								
S	M	T	W	T	F	S																																																																																																		
		1	2	3	4																																																																																																			
5	6	7	8	9	10	11																																																																																																		
12	13	14	15	16	17	18																																																																																																		
19	20	21	22	23	24	25																																																																																																		
26	27	28	29	30	31																																																																																																			
Oct 2012																																																																																																								
S	M	T	W	T	F	S																																																																																																		
7	8	9	10	11	12	13																																																																																																		
14	15	16	17	18	19	20																																																																																																		
21	22	23	24	25	26	27																																																																																																		
28	29	30	31																																																																																																					
<i>2</i>	<i>3</i> Dave, KD8RFY BD	<i>4</i> 7:00 PM Stark Cty ARES Net (147.12) 9:00 PM Northern Columbiana Cty Training Net (147.255)	<i>5</i> Cuyahoga Falls FoxHunt	<i>6</i> 7:00 PM PCARS Net (146.895) 8:01 PM AARC CW (28.100 MHz) 8:30 PM AARC SSB(28.400 MHz) 9:00 PM AARC VHF (145.37(-)) Gladys, KB8GIA BD	<i>7</i>	<i>8</i> Allen, WI8T BD John, W0OZZ BD																																																																																																		
<i>9</i>	<i>10</i>	<i>11</i> 7:00 PM Stark Cty ARES Net (147.12) 9:00 PM Northern Columbiana Cty Training Net (147.255)	<i>12</i> AARC Meeting	<i>13</i> 7:00 PM PCARS Net (146.895) 8:01 PM AARC CW (28.100 MHz) 8:30 PM AARC SSB(28.400 MHz) 9:00 PM AARC VHF (145.37(-))	<i>14</i> 8:00 PM Massillon Net (147.18)	<i>15</i>																																																																																																		
<i>16</i>	<i>17</i>	<i>18</i> 7:00 PM Stark Cty ARES Net (147.12) 9:00 PM Northern Columbiana Cty Training Net (147.255)	<i>19</i> Barry, AB8YE BD Cuyahoga Falls FoxHunt Tom, KD8JRK BD	<i>20</i> 7:00 PM PCARS Net (146.895) 8:01 PM AARC CW (28.100 MHz) 8:30 PM AARC SSB(28.400 MHz) 9:00 PM AARC VHF (145.37(-))	<i>21</i> 8:00 PM Massillon Net (147.18)	<i>22</i> <div style="border: 1px solid black; padding: 5px; width: fit-content; margin: auto;">7:00 PM AARC Foxhunt</div>																																																																																																		
<i>23</i>	<i>24</i> Mary, KD8RFZ BD	<i>25</i> 7:00 PM Stark Cty ARES Net (147.12) 8:00 PM Homeland Security Net (147.51) 9:00 PM Northern Columbiana Cty Training Net (147.255) Smitty, KC8TJQ BD	<i>26</i> <div style="border: 1px solid black; padding: 5px; width: fit-content; margin: auto;">7:00 PM AARC Foxhunt</div>	<i>27</i> 7:00 PM PCARS Net (146.895) 8:01 PM AARC CW (28.100 MHz) 8:30 PM AARC SSB(28.400 MHz) 9:00 PM AARC VHF (145.37(-))	<i>28</i> 8:00 PM Massillon Net (147.18)	<i>29</i>																																																																																																		
<i>30</i>																																																																																																								

Alliance Amateur Radio Club
P.O. Box 3344
Alliance, OH 44601

The AARC Wayback Machine

Here again are some of the highlights from the last 20 years of the Zero Beat. you can read them at <http://www.w8lky.org/newsltrs/>.

September, 1987 (Editor, N8IAK)

- Our Ham of the Month was Hal, W8BGI.
- We had what may have been our first ever foxhunt, which was followed by a club picnic at the Kiwanis pavilion, at Butler Rodman park.
- The talk at the September meeting was to be hosted by Jack, W8WEN. The subject was to be "Antenna Rotators".
- Novice classes were to be held in the fall. The instructor was to be John, KD8MQ

September, 1992 (Editor, N8LVO)

- Preparations were being made for the mall show which was scheduled for September 12/13. No raffle this year, and clubs from Salem, Canton, and the Alliance YMCA Youth Radio Club had been invited to set up displays.
- The 1992/3 roster listed 32 paid club members.
- Jerry, AA8GY gave a technical description

of his sloping horizontal loop antenna.

September, 1997 (editor, N8SH)

- We had a wrap-up article on the Club picnic, and corn roast, which was held at Bob Rickards place, north of town.
- This years mall show was to be held on September 6/7.

September, 2002 (editor, KD8MQ)

- This was to be KD8MQ's last issue of the Zero Beat (yeah, right!). I resigned, so I could devote more time to my schoolwork. As of that issue, a replacement editor had not been named.
- Don, K8OMO set up a display promoting the club at the Carnation festival Pump-In, on August 11, 2002.
- Another triathlon was behind us. Everything went off "without a hitch".
- According to the August minutes, brochures, & reference cards had been printed, and were ready in time for the club booth at the Mile Branch Grange Fair.

(Continued on page 5)