



## Celebrating Our 25th Anniversary!

Volume XXVI, no 5

<http://www.w8lky.org>

May 2012

Serving the Tri-County area since 1986

### Table of Contents

April Minutes	3
Calendar	21
Canton Marathon	4
Contact Us	2
Contest Winner	7
Club Info	2
Fox Hunt Results	19
Fox Hunt Schedule	19
Hamvention Bus Trip	20
HT Raffle	1
K8LTG Repeater	1
K8LTG Anecdote	10
KB6NU Column	6
Meeting Announcement	1
Net Format	5
Net Info	2
Rambling by KD8MQ	2
Senate Bill 158	11
Simplex group to meet	4
Tomorrows Lottery numbers	24
Used Antennas, or Arc Generators?	13
Wayback Machine	22
Welcome New Members	12

## K8LTG Repeater is Willed To Club

As some of you know, some major changes have occurred concerning the 145.370 repeater. As reported last month, Jim, K8LTG, who owned the repeater passed away. It was learned soon after that Jim had made a sizable donation to the club.

While the scope of the donation remains to be seen, we know that it includes the 5.37 repeater.

Don, K8OMO who has been the control op for 5.37 for several years has changed the callsign on the repeater to W8LKY. In addition he has made some recommendations for members to serve on a repeater committee.

Other than that, not much else has changed. 5.37 is still open to all, and still hosts the Thursday night 2 Meter net. Jim's intent when he bought this machine was to preserve it for the club until such time that the club was able to support it on it's own.

We'll be discussing this in more detail at the May meeting.

## Wouxun HT To Be Raffled By Club



Last month, an anonymous benefactor donated a Wouxun HT to the club. It was donated with instructions that it be raffled off for the good of the club.

Details were finalized at the April club meeting, tickets were printed, and the clubs first raffle in 20 years is now underway.

Tickets are \$1 each, or 6 for \$5. If you'd like to be one of the first to buy a raffle ticket, come to the next meeting. Please contact John, KD8MQ for information.

### Meeting Announcement

Our next meeting will be on Wednesday, May 9<sup>th</sup>, 2012 at the Alliance Community Hospital, in the Cafe conference room. Our meetings begin at 7:30 PM.

This month's program will be presented by Tony, KD8BBK, on **Ham Radio Deluxe.**

At 6 PM, you're invited to join us for dinner at the

**Alliance Family Restaurant,**  
428 E. State St.

## Officers

### President

KD8MQ  
John Myers  
910 West Mill St.  
Alliance, OH 44601  
[kd8mq@neo.rr.com](mailto:kd8mq@neo.rr.com)  
330-936-5021

### Vice-President

K8DXR  
Howard Miller  
10626 Dot Ave.  
Alliance, OH 44601  
[hmliller32@neo.rr.com](mailto:hmliller32@neo.rr.com)  
330-821-9392

### Secretary

AB8KV  
Donald R Kingan  
446 West High St.  
Alliance, OH 44601  
[dkingan@neo.rr.com](mailto:dkingan@neo.rr.com)  
330-821-5819

### Treasurer

KB8IVS  
Mary Ann Royer  
6255 Sandalwood NE  
Canton, OH 44721  
[kb8ivs@aol.com](mailto:kb8ivs@aol.com)  
330-492-0703

### Trustees

WA8WHP  
Frank Sanor  
2142 Blenheim Ave  
Alliance, OH 44601  
[wa8whp@juno.com](mailto:wa8whp@juno.com)  
330-206-2639

KD8BBK  
Tony Shillig  
8980 Paris Ave  
Louisville, OH 44641  
[kd8bbk@aol.com](mailto:kd8bbk@aol.com)  
330-875-0085

KD8KMQ  
Ben Davis  
4561 Anderson Ave, NE  
Homeworth, OH 44634

### Editor

John Myers, KD8MQ  
(See above)

## Rambling

By John, KD8MQ

Hi everyone. Welcome to the May issue of the Zero Beat. This is an unusual issue in that this column wasn't finished by the deadline. It is usually the easiest column to write, therefore the first one done. But, you know how things go. There's a lot to talk about this month. So, let's get right to it.

**Raffle** - First, I'd like to thank the anonymous benefactor who donated the Wouxun dual band handheld radio for the club raffle. Tickets are printed, and ready to distribute. Catch me at the next meeting if you want tickets to sell.

**Club Meeting** - There's a lot of stuff happening at the next meeting. Among other things, we'll be learning about the equipment that was bequeathed to the club in K8LTG's will.

Also, we'll be discussing not only Field Day, but also the annual AARC Special event station in August.

**The 3rd Annual Stark County VHF QSO Party** is history. I'll score them this weekend, and unveil the results at the club meeting. The deadline is past, but I'm giving a couple extra days for the US mail to get all of them to me.

**Thanks** - I've signed up for a couple new Yahoo groups this month. So far, I'm enjoying what they have to offer. In corresponding with a new friend off-list, I was describing our club, and how we operate.

As I was relating the story of how we came to hold a raffle, I realized yet again just how lucky I am to be associated all of you. We aren't a rich club by any means, but we have members who are willing to step up and do what needs to be done for the good of all. That makes me feel like a member of the richest club on earth.

Whether donating something for an event, or offering to take care of some crucial task, I sometimes don't have to ask, and it is handled.

The weak link is usually that I have a hard time asking for help. But, in case I have haven't done so lately, I'd like to say Thanks to each & every one of you who work behind the scenes usually with little or no recognition.

That's all I have for this month. I hope to see you at the next meeting.  
73, de John, KD8MQ

## Meetings

The Alliance Amateur Radio Club meets on the Second Wednesday of each month. Check the meeting announcement on page 1, for the location. Talk-in is on 145.37 ®. Meetings begin at 7:30 PM. Visitors are always welcome.

## Nets

Thursday is our "net night," with the following nets held:

### Ten meters

CW @ 8PM on 28.400 MHz  
SSB @ 8:30PM on 28.400 MHz

### 2 meters

9 PM on 145.37 MHz

The Homeland security Net meets on the last Tuesday of the month, at 8:00 PM, on 147.51 simplex

## Internet

**Web:** [www.w8lky.org](http://www.w8lky.org)

**E-mail:** [W8lky@w8lky.org](mailto:W8lky@w8lky.org)

**We are also on Facebook!**

## Newsletter Information

The Zero Beat is a publication of the  
**Alliance Amateur Radio Club**  
**P.O. Box 3344**  
**Alliance, OH 44601**

Unless otherwise noted, permission is granted to reprint portions of the Zero Beat, as long as credit is given to the author & source.

You can submit material to the Zero Beat via e-mail to [kd8mq1@gmail.com](mailto:kd8mq1@gmail.com)

## April Minutes

April 11, 2012

The regular meeting of the Alliance Amateur Radio Club was held on April 11, 2012 at 7:30 PM in the first floor conference room of the Alliance Community Hospital with club President John Myers (KD8MQ) presiding. The pledge of allegiance was recited followed by introductions. There were 19 members present along with Miriam Sanor and guests Terry Russ (N8ATZ), Wade Huthmacher (WD8MIU), Chuck Lazear (N8PLM), Noah Kee (KD8SBS) and Eddie Kee (KC8HUU).

President John announced a birthday for the month which was Joe Young (KC8TAC).

Secretary Don (AB8KV) gave the Secretary's report, noting that the March meeting minutes were in the newsletter and that he had taken care of ordering the flowers for Jim Ferguson's (K8LTG) funeral. He then reported on the condition of Dave (N8NLZ) and suggested that if anyone wants to visit, please call first and keep visits short. As always, cards and phone calls are appreciated. With nothing further, the Secretary's report was approved on a motion from Frank (WA8WHP) and seconded by Jeff (KD8QCF).

Treasurer Mary Ann (KB8IVS) then gave the Treasurer's report, reminding the club that annual dues

were now due. The report was approved on a motion by Smitty (KC8TJQ) and seconded by Tony (KD8BBK).

### Announcements:

- President John reminded the club about the upcoming Cuyahoga Falls hamfest as well as the PCARS bus trip to the Dayton Hamvention, noting that as of the meeting, a few more sign-ons were needed to firm up the trip.

- John reminded the club that he is still accepting remembrances or anecdotes from people about Jim Ferguson, for publication in the newsletter.

### Committee reports:

- Regarding ARES and nets, Don (K8OMO) reported that the last Homeland Security net had quite a few check-ins and is normally covering four counties. He further noted that the 10-meter nets are typically having 6 to 8 check-ins. He added that if the 28.400 frequency is busy at the time for the CW net, it would be held on 28.100. The side-band net will remain on 28.400.

- John then noted that the General classes were now completed, with four attendees upgrading their licenses to General class. These were Paul (KA8NME), Mike (KD8RUQ), Steve (KB8RFE) and Patty (KB8QWH).

### Old business:

- President John announced that the pre-Field

Day club picnic will be held the second week of June, on Wednesday the 13<sup>th</sup>. It will be at the cabin in Silver Park.

- Frank then announced the winners of the 25<sup>th</sup> anniversary certificate and QSL card contest. The winning certificate was by Paul (KA8NME) with the winning QSL card by Jeff (KD8QCF). John then asked Frank to check on the cost of having these items printed.

- John noted that for Field Day, the Sebring campground has now been reserved. Further plans will be discussed at the next meeting.

- John then reported on the Stark county VHF QSO party, noting that the participation was about the same as last year.

### New business:

- John told the club he had received a phone call from an anonymous donor who was giving a dual-band radio with programming cable to the club to be raffled off. John then asked for suggestions as to how to do the raffle, whether at the next club meeting or sell tickets over an extended period of time before holding the drawing.

John noted that he had already obtained a quote for 250 tickets (\$15-\$20) or 500 tickets (\$30-\$40). After some discussion, it was agreed that allowing an extended time to sell more tickets was desirable, with the majority opinion being to

## April Minutes—cont.

hold the drawing on Field Day.

A motion to do just that, along with purchasing 500 tickets, was made by Frank and seconded by Tom (KD8JRK). The motion was passed. The question of what to charge for the tickets was then addressed. With further discussion, it was generally agreed to sell them for \$1 each or 6 for \$5.

- John inquired whether there was any update regarding the estate of Jim Ferguson. Don (K8OMO) reported that nothing was ready for publication as yet, with legal arrangements still pending.

- Frank then announced that his Cub Scout pack has a fund-raising can at Ponder-

osa where patrons can drop in their receipts and/or make a donation.

- With no other business, the club broke for refreshments.

- After the break, Terry and Wade spoke about the first annual Canton marathon to be held on June 17 starting at 6:00 AM. There will be a full marathon, a half marathon and a 10K run. They stressed the need for ham volunteers to assist with communications.

- Tony then demonstrated a new multi-band QRP rig he had obtained.

The meeting was adjourned at 9:07 PM. Minutes respectfully submitted by Don (AB8KV), Secretary.

## Simplex Group to Meet for Breakfast

Hello this is Tomas St George, kc8zeh. I would like to let you know that we are going to have breakfast at Walters cafe on May 5<sup>th</sup>, 2012 at eight AM.

Walters is located at the corner of 19th St., NE and Maple Ave, NE in Canton. You'll be able to order off the menu, or just have coffee. You'll be able to finally put a face to the call-signs you hear every day. This is totally informal; feel free to bring the wife, and kids ,or bring your friends. You don't have to be a ham to attend.

Its been over a year since we got together. Some

of us have changed call signs; some of us have gained weight and some of us have lost a bunch of weight.

If you need help finding the place we will be on 146.535 simplex. If you have questions call me at [330-452-2390](tel:330-452-2390). I hope to see all of you there.

Thanks,

Tomas St George

PS - we will be in the banquet room at the north end of Walters. Go Thru first door make a left into Walters then make another left down the hall, then first door on the left.

## Your Help is Needed for the Canton Marathon!



The Stark County ARES has been requested to provide safety and support communications for the first annual Canton Marathon which is scheduled for Sunday, June 17th, 2012.

Multiple public safety agencies are currently planning for this large scale event and amateur radio operators are also working with event organizers to determine our participation which is expected to include staffing operators along the route, shadowing race officials, aid stations and SAG support.

Please consider volunteering for this very important community event which will showcase amateur radio to the community. We hope to provide a minimum of 25 operators in support of this event.

Please contact Communication Coordinators Wade Huthmacher, WD8MIU by email to [wd8miu@gmail.com](mailto:wd8miu@gmail.com) phone (330) 704-2100 or Terry Russ, N8ATZ to [truss@sssnet.com](mailto:truss@sssnet.com) phone (330) 837-3091.

# Z e r o B e a t

## AARC Two Meter Net Format

This is w8lky tri-county news, training, information and swap net

The Alliance Amateur Radio Club meets at the Alliance Community Hospital on the second Wednesday of the month in the rear of the cafeteria at 7:30 pm. the next meeting will be **<date time>**. visitors are always welcome.

----- break for time-----

Your net manager is Oliver Smith KC8TJQ in East Rochester. Tonight's net control station for the w8lky net is **<Your name and call>**

This is a directed net. It's purpose is :

1. To provide training for our members in net format & operations.
2. To handle traffic to & from Alliance, and the surrounding areas.
3. To provide a forum for announcements, and points of interest to hams in and around the area.

We now officially open this net to any stations with emergency or priority traffic or routine traffic .only those stations with traffic please come now.

Stations with emergency traffic may break this net at any time.

Mobile stations will be placed at the top of the list .

I now take pleasure in accepting check-ins for the net . all check-ins please call w8lky now , with your call, name, and QTH.

After the check-ins are done, acknowledge those who check in for each round, by call name ,& location if given.

**Round two** - looking for check-ins , echo link or other additional check-ins. come now

Any announcements ? break

Anything good for the net? break

**end**

Since there are no further check-ins We'll thank the CLUB for the use of their repeater, and return it to normal amateur operation. thanks to all who brought information ,traffic, or just checking in .without you we would have no net ,you make the net.

for w8lky this is **<Your call sign, name>** 73's and goodnight all

send reports to Smitty KC8TJQ

# Mailing lists, blogs, and podcasts are good sources of ham info

Whether you're a new-comer or an old-timer, the Internet is possibly the best way to learn as much as you can about amateur radio. On the Internet, you'll find many, many ham radio mailing lists, podcasts, and videos. In essence, these resources give you access to hundreds, if not thousands, of Elmers.

One mailing list that I always suggest to new hams is the HamRadioHelpGroup (<http://groups.yahoo.com/group/HamRadioHelpGroup>). The purpose of this group is to help "those who are interested in getting started in Amateur Radio or upgrading their license." This mailing list has a good mix of beginners and experts, and most questions are answered quickly and correctly. One thing that I really like about this group is that the moderators do a good job of keeping the discussions on track, and will squelch them when they stray off topic or threaten to turn into flame wars.

In addition to the HamRadioHelpGroup, you might also want to join a more targeted mailing list. For example, if you're interested in learning Morse Code (hint, hint), you might join the SolidCpyCW list (<http://groups.yahoo.com/group/SolidCpyCW/>). If you just bought a Yaesu FT-60 handheld transceiver, you might

want to join the FT-60 list (<http://groups.yahoo.com/group/FT-60/>). Chances are that no matter what your interest, there's probably a mailing list to discuss that interest.

I'm subscribed to a lot of amateur radio mailing lists and could probably spend most of my day just reading and replying to them. In order to get the most out of them, without them taking away from my on-air time, I only read those threads that I am really interested in, and even then, I quit reading them once they have started to drift off-topic. I also unsubscribe myself from lists that cover topics that I'm no longer interested in.

### Blogs, podcasts and videos

In addition to getting on a few mailing lists, you might want to read a few blogs and subscribe to podcasts. These are also great sources of information about amateur radio. I blog about amateur radio at [www.kb6nu.com](http://www.kb6nu.com), and lots of hams find it a good source of information. You can find a list of other ham radio blogs that I'd recommend on my home page.

Podcasts are also a good source of information. One podcast that you might want to check out is the Practical Amateur Radio Podcast.

[www.myamateurradio.com](http://www.myamateurradio.com)

Since 2008, Jerry, KD0BIK, has been producing PARP, and currently has more than 50 different episodes online. For other podcasts, consult the list on Jerry's home page.

Finally, there are literally thousands of amateur radio videos on the net. On YouTube alone, there are approximately 32,000 of them. The American Radio Relay League has its own channel (<http://www.youtube.com/user/ARRLHQ>), but perhaps the most popular amateur radio video channel is the K7AGE channel (<http://www.youtube.com/user/K7AGE>). K7AGE has more than 6,200 subscribers and his videos have garnered more than 2.1 million views!

Whatever source or sources of information you select, remember to not let them take up too much of your time. Ham radio is about more than just reading, listening, or watching. It's about doing!

=====  
=====



When he's not answering yet another e-mail, Dan blogs about ham radio at [www.kb6nu.com](http://www.kb6nu.com), teaches ham classes, and ragchews on 30m and 40m CW. You can e-mail him with comments or questions at [cwgeek@kb6nu.com](mailto:cwgeek@kb6nu.com).

Design a club QSL Contest Winner

1987 2012

*25th Anniversary*  
of the  
*Alliance Amateur Radio Club*

**W8LKY**

Confirming QSO with:

Station		Date	UTC
MHz	RST	Mode	QSL
			Pse / Tnx

Alliance Amateur Radio Club  
PO Box 3344, Alliance, Ohio 44601

Stark County - Grid EN91

**Ohio's state flower**, the Scarlet Carnation was propagated by Alliance resident, politician and amateur horticulturist Dr. Levi Lamborn in 1866, which he named the "Lamborn Red".

In 1876, while running against William McKinley for the 18th Congressional District Dr. Lamborn presented the future president with a scarlet carnation before each debate. From this point on the Lamborn Red became a favorite of former President William McKinley who spoke of it as a good-luck charm. When he became president, he took to wearing one at all times.

President McKinley was killed by an assassin's bullet on September 14, 1901 shortly after removing the flower from his lapel to give it to a young admirer at the Buffalo Exposition.

The scarlet carnation became the state flower on February 3, 1904 after the Ohio General Assembly passed a joint resolution naming it the state flower of Ohio. On April 1, 1959, the Ohio Legislature recognized Alliance as the "Carnation City."

**Glamorgan Castle** was built between 1901 and 1905 as the family home of the late Col. William Henry Morgan. Col. Morgan was the president and principal owner of the Morgan Engineering Company, which was founded by his father, Thomas Rees Morgan, who had immigrated from Glamorganshire, Wales in 1865. Col. Morgan lived here with his family until his death in 1928. Currently the castle is home to the Alliance City School District's Administrative offices.

**Remarks,**

---



---



---



---



---



---

Congratulations go out to Jeff, KD8QCF for designing the first place entry in the Club QSL contest. These will be used for all contacts with W8LKY during 2012

**Design A Club Certificate Contest Winner**



Here's the winning entry in the contest to design a certificate for the club special event station. It was designed By Paul, K2ASA.



These came in too late for inclusion for last months issue. Thanks to Tom, KC8QOD for the shots of the finish line for the March fox hunt. Frank is gloating about catching the hunters!



# Alliance Amateur Radio Club HT Raffle!

## Win a Wouxun HT!



The Alliance Amateur Radio club is raffling off a **Wouxun KG—UVD1P Dual-Band HT!**

The winner will be drawn on June 23rd, at 5 PM, at our Field day site! **Sebring Campground 895 McKinley Ave, Sebring, OH**

Winner need not be present to win!

[www.w8lky.org](http://www.w8lky.org)  
Tickets available from any club member!



Tickets only \$1 each or 6 for \$5

## How do I remember Jim?

I worked with Jim for 9 years and we used to meet at break time and talk about Ham radio related things like when the next hamfest was coming up and where -- or a million other related items. The thing that made Jim great is that he had a real interest in other people and helping them succeed through encouragement and having a genuine interest and thoughtfulness about him.

Jim was a good listener and a conversation with him was fulfilling as he would tell stories about related things he had done in his life. Shortly after we started talking in the break room Jim started encouraging me to get my extra class license. So every day he would give me a little push in that direction -- before long I started to work on the 20 words per minute speed. I took the test 10 or 20 miles east of Alliance --it's been 20 years now. One thing is sure I would not have upgraded it had not been for Jim's gentle prodding.

Some of the other things that I've done that were heavily influenced by having Jim and other members of the Alliance ham radio club like

W8WEN, and K8OMO, around are the homebrew ham radio receivers I've built, the interest in old Ham gear that has grown to include 2 ham receivers from the 30s, an interest in old and telegraph keys, and attending the local ham fests. It's nice to have the encouragement and interests of other people in your projects. Back 20 years ago I was the only one doing much building of ham radio projects locally but what motivated me was talking about the projects with Jack, Jim, and Don. It's impossible to name the number of hamfests that I've hung around with Jim but some of the best were probably were Goodyear, Ravenna, Warren, Canfield and Massillon.

Any time I mentioned an old ham or military radio of a particular type Jim was always offering to give me one of the same type he had stored away regardless if it was a radios or a part. He was always ready to give away anything he had. He was always ready to be generous with his time or his things.

One of the things that impressed me was Jim building the HBR-11 receiver and completing

the project. K8OMO had found an HBR at an estate sale that I bought. Jim told me that he had always wanted to build one when he saw the one I have. I happened across another HBR-8 at the Warren hamfest and repaired it as it had never worked and gave it to Jim. Jim was not impressed with the HBR-8s construction style in that the parts were packed and stacked in tight to fit in a small cabinet and decided he would rebuild it to a higher standard. Jim undertook the task of gathering all the additional parts and built a beautiful HBR-11.

Possibly only someone who has built radios from scratch knows the level of effort involved. Just building the plug in coils is a extremely tedious process. A strange thing is I haven't run across another HBR receiver since those two.

Jim used to drop by my place and he always made a point of spending a little time with my family and they always enjoyed his visits. Jim and I drove down to Steubenville together last year to visit Hostfelts' and enjoy the ride. Don and I have made the same trip -- usually on

*(Continued on page 11)*

## Jim- cont.

*(Continued from page 10)*

sunny days -- the travel in life can be as important as the destination.

Jim was alive and planned on living much longer --he had just bought a set of Gonset ham radios and an old Ford to fix up. We had made plans for Jim to take me and my family for a ride around the block in the Ford this summer and we discussed the Gonset receiver and transmitters specifications in our last bull session 2 weeks before his death.

It really saddens me that we won't be hanging out again. Our conversation was not that of 2 friends who never expected to talk again --it was about the things we planned to do. Jim looked healthy but because he had health problems in the past I was thinking after the visit he might be around another 10 years. I'm going to miss Jim terribly just as many others will --but my life has been so much more fun as a result of the time we spent hanging out the last 20 + years. 73 N8DZA/ K8LTG de N8SH

## Ohio House Bill 158 Passes Senate Floor Vote!!

(The following is from our Ohio State Government Liaison, Nick Pittner, K8NAP. I would like to take this time to thank Nick, and the many, many others who donated their time to get this Bill to where it is today. For video of today's legislative passing, visit <http://www.ohiochannel.org/MediaLibrary/Collection.aspx?collectionId=108260> Start at the 10 minute mark within the April 24th video.

73, Frank Piper - KI8GW) Ohio amateurs' antenna legislation cleared a major hurdle today when H.B. 158 was approved by the Ohio Senate. The Bill has now passed, though with minor differences, in both the Ohio House and the Ohio Senate and our ultimate goal of having this legislation become law appears to be within reach. The two remaining steps are, first, consideration by the House of the amendments made by the Senate. Those amendments essentially deleted the 75' presumption of reasonableness for tower height. The standard under the bill as passed is similar to that required by FCC regulation PRB-1, which is reasonable accommodation and minimum practicable regulation of antennas. Unlike PRB-1, however,

the Ohio legislation places the burden of proof on any legislative authority denying a request for zoning variance to demonstrate compliance with the Ohio statute.

We believe that the House will be supportive of the changes made by the Senate, as both of the primary sponsors, Representatives Stebelton and Okey, have indicated their support, and members often defer to the Sponsors when differences such as these arise. Following House reconsideration, the next step is Governor Kasich, who must approve the legislation in order for it to become law. Even that approval does not instantly transform the Bill into law, as a 90 day waiting period will be required before the law goes into effect. Notwithstanding all of that, today's vote was a milestone in our nearly 5 year effort to secure passage of this legislation. We continue to believe that this legislation will make it easier for many Ohio amateurs to more fully enjoy their hobby as well as to prepare for and participate in emergency communications as the need arises.

73,  
Nick Pittner, K8NAP

## Wayback Machine - cont.

continue as editor.

- Dave ran a story entitled "Duping Made Easy", which advocated working stations in alphabetical order.

- Father Moran, 9N1MM passed away at the age of 85.

- The "Mother of all fox hunts" was promised in May, 1992.

**April, 1997 (Editor, N8SH)**

- Jim, K8LTG penned an interesting article on Ham Radio, the way it used to be.

- Jim, K8LTG was appointed the clubs Public Information Officer.

- There was a profile of Dave, W8UKQ,

**May, 1997 (Editor, N8SH)**

- There was a story by N6YM, on "Old Tyme Radio". It described what may have been the first commercial station in the US. According to the author, it was **not** KDKA!

**April, 2002 (editor, KD8MQ)**

- KD8MQ, & KE8VE were continuing an exercise in tag-team newsletter editing. This allowed KD8MQ to keep what was left of his sanity, while attending college.

- The big Super-Meeting sponsored by the Canton ARC was coming up. Joe, K8QOE was to be the speaker. It was hoped that representatives of the nine Stark County clubs would attend.

**April, 2007 (editor, KE8VE)**

- Frank had been named Ham of the Year. We must've not gotten around to posting a picture of him with the plaque, until the April issue.

- Dave Glass, W8UKQ had become a silent Key. More

- We were researching alternative Field Day site within the Alliance city limits. Among sites which were being considered were Glamorgan Castle, and Alliance Middle School.

- OMO was inquiring about installing the K8LTG repeater, as well as the Homeland Security radios at the Alliance Community Hospital.

**May, 2007 (editor, KE8VE)**

- A story reprinted on page 1 asked the question "What Ever Happened to the Electronics Hobbyist?".

- A Field Day networked software demo was being planned for the May club meeting.

- According to KE8VE, the Zero Beat was to have a "New & Improved" editor soon. KD8MQ was set to take the reins again. Larry had taken over as editor so I could better concentrate on my school work.

- After some discussion, it was decided to return to our usual Field Day site at Marlinton Middle School.

## Welcome New Members

This is one column I never get tired of running in the Zero Beat. If people are joining, that gives hope that people see what we're doing, and want to be a part of it.

This month, I'd like to welcome Steve, and Patty, KB8RFE, & KB8QWH. Also, a big welcome aboard to Paul, KA8NME, who recently received his new callsign; K2ASA. Last, but not least, is Mike, KD8RUQ. Rumor has it that Mike recently passed his Extra exam. Way to go Mike!

PS, though she isn't a new member, a big congrats goes out to Mary, KD8RFZ, who recently passed her General exam.

Lastly, we have two new members from the Canton area. They are Eddie, KC8HUU, and Noah, KD8SBS.

Keep em coming, folks! I'd love to run this column each & every month!

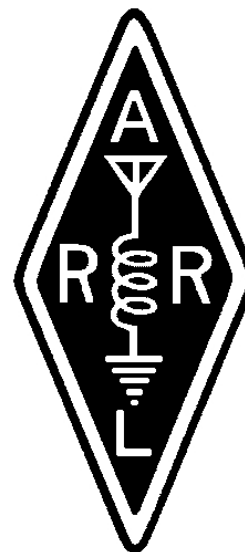

G1204

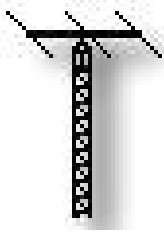

## USED ANTENNAS

Or

## Arc Generators ?



The opportunity has arrived and a used multi-band antenna becomes available. It can be in the form of a Tri-Band Beam, Trap Vertical, or other type of Multi-Element variety. Before installing the “used” antenna, maybe a closer look is necessary.



After years of use in all weather conditions, hardware becomes loose, corroded, and generally deteriorated. Seals can become brittle, allowing water to enter into components.



If not reconditioned, the antenna can become intermittent. During transmission and various weather conditions, loose connections can arc, causing abrupt changes in impedance (SWR) which may destroy components in the radio. (Many radios claim to be protected against high SWR but arcing creates unpredictable operation). Arcing causes interference to the RF spectrum similar to power line noise. This can cause interference inside and outside of the amateur bands to other services.

Here are some examples of a tri-band mini-beam (estimated at 300 watts) likely from the early 1970's. This design covers only the phone or CW part of the 10M/15M/20M band due to its smaller size. To drain water, install the traps with the 4 holes pointed downward.



Page 2:

The following example shows a 10M trap that has a broken insulator. This trap should be replaced if available. Repair would be difficult.

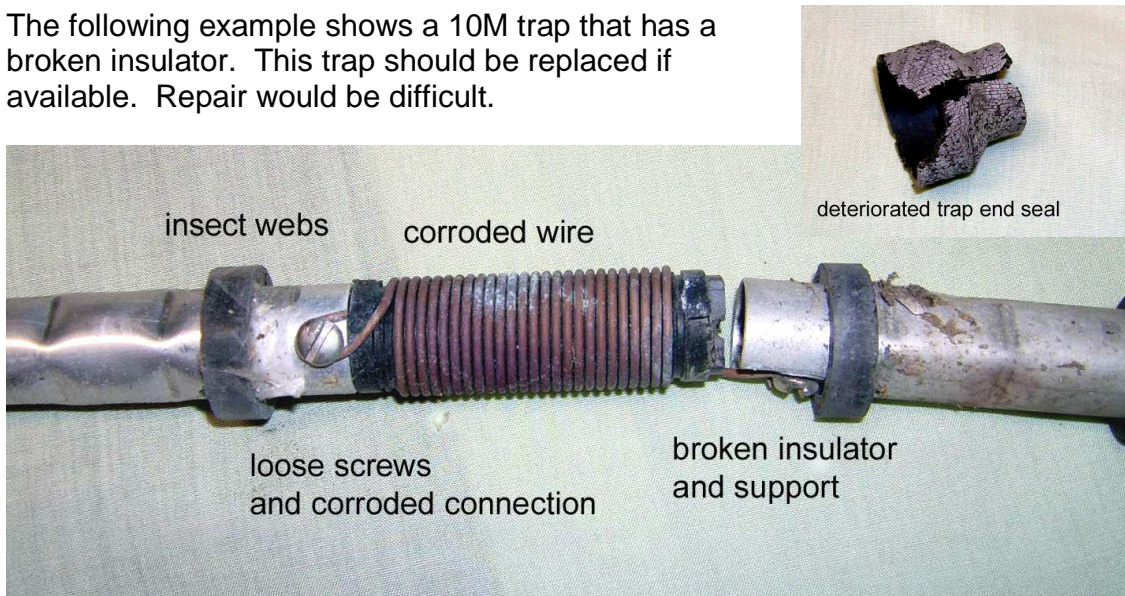

Disassembled 15 Meter Trap showing problem areas:

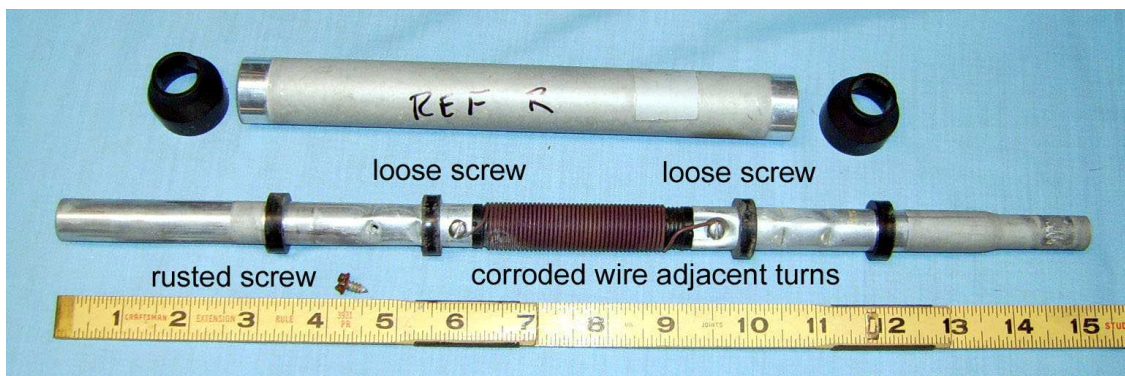

The copper coil can be unwound only if you are experienced in wire straightening and doing a tight rewind. Otherwise skip to alternate cleaning method.



15 Meter Trap after the copper coil was removed. Center insulator was cleaned with alcohol. Aluminum was polished with 600 grit wet/dry sandpaper & water, then cleaned with alcohol.

### Removing & rewinding copper winding & cleaning, Or skip to the Alternate Cleaning Method

- Remove one coil screw, leave the wire hook at each end
- Unwind the wire in a straight line while rotating the trap then remove remaining screw
- Clean the wire with 600 wet/dry sandpaper, then clean with isopropyl alcohol. **Steel wool is not recommended since some of the pieces can end-up in the trap and cause further problems**
- Clean the trap insulator with a new toothbrush and isopropyl alcohol and let dry.
- Clean the aluminum tubing with 600 wet/dry sandpaper & water and a final cleaning of isopropyl alcohol
- Install the wire in reverse order by first securing one end with a tightened screw. To keep tension and straighten the wire, wrap 2 to 3 turns of the beginning wire around a ½ inch copper pipe (held in a vise) and pull the wire tight while winding the coil. This will straighten the wire but may lengthen the wire by about 1 turn.
- Finish installing the wire and trim as necessary to keep the same number of turns. Install the other screw
- Tighten both screws

### Alternate Cleaning Method of the trap coil

- Clean the coil with a new toothbrush and isopropyl alcohol
- Lightly clean the copper with 600 wet/dry sandpaper & water
- Clean the coil with a toothbrush and isopropyl alcohol and let dry
- Remove each screw holding the wire for the coil and clean the wire ends
- Reinstall the wire end and tighten the screw



Page 4:

All parts cleaned. Rusted hardware replaced. Aluminum should be a bright finish after using sandpaper and/or scotch-brite pad and a good cleaning.



### TESTING THE TRAPS

Picture shows testing the resonant frequency of the 15 Meter Trap. The trap needs isolated from any metallic surface. Use a cardboard box or items such as cardboard tubes to keep the trap from surfaces that could change the resonant frequency.

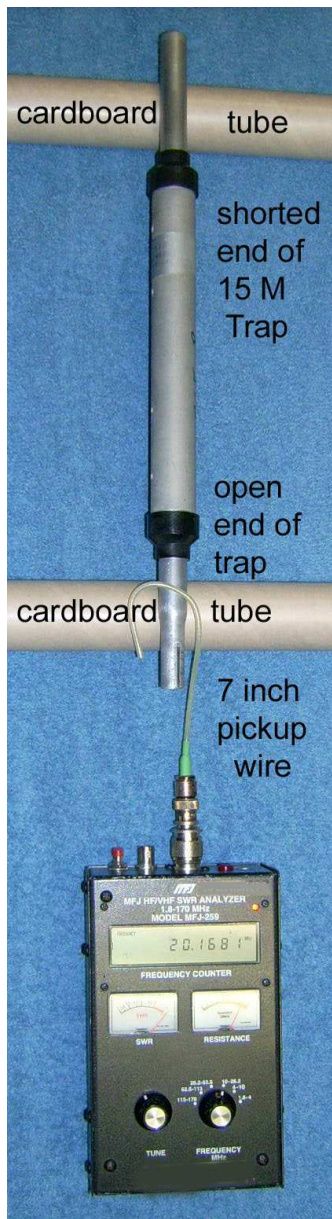

The trap has 2 different ends. On one end there is a screw that electrically connects the outer aluminum tube to the inside tube (this tube is the capacitor part of the parallel resonant circuit along with the inside coil.) This end of the trap goes toward the center of the beam (ground side of the beam or bottom end on a vertical). The other end is insulated and goes away from the beam or toward the sky on a vertical.

The Antenna Analyzer samples the resonant frequency on the insulated end of the trap as shown. The 7 inch pickup wire shown goes directly to the center conductor of the BNC or PL259 connector. The wire is insulated and does not electrically touch the trap. This is a capacitive coupling method.

Tune the frequency slowly and notice the small dip in the SWR meter reading. The meter change is only about 1/16 of an inch. This change is so small that it can be easily missed. The frequency where the dip occurs is lower than the resonant frequency of the internal trap, due to the extra metal tubing. In this case the reading was 5 % lower than the actual resonant frequency of the internal trap. Longer tubing will lower the observed frequency. This shows that the traps are working and comparing traps that have the same length of tubing will be a good check of the system.

Internet references show observed readings to actual resonant frequency for some antenna manufacturers.



## THE BALUN

**Right picture:** The BALUN as removed from the Mini-Beam. This is an optional 50 ohm balanced to 50 ohm unbalanced transformer.

The inside case is in need of cleaning and the SO-239 connector outer shell is broken. The ferrite rod glue needs replaced.

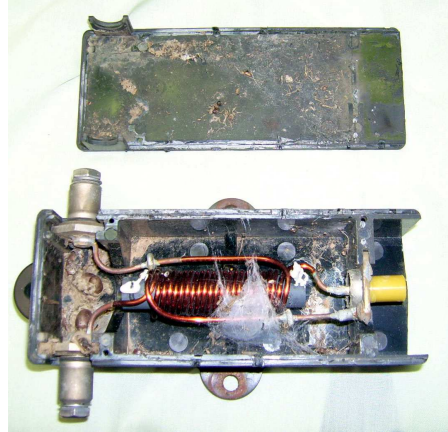

**Picture below:** The same Balun has been cleaned, resoldered, and a new SO-239 connector has been installed. The wires have been painted for illustration to identify the 3 windings.

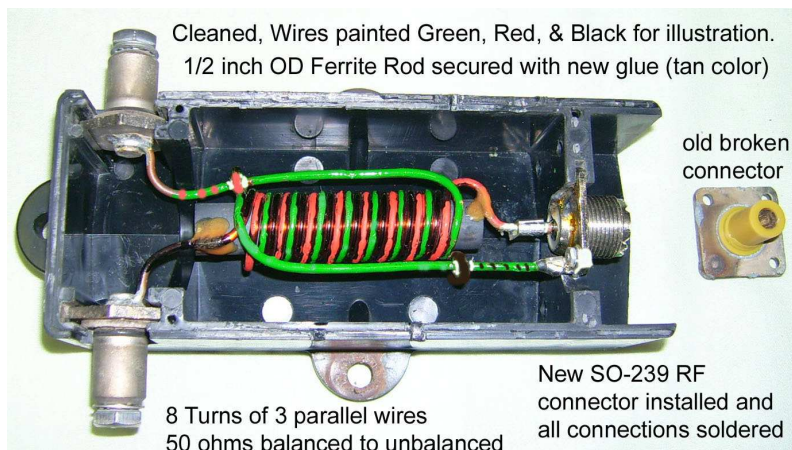

To determine the output impedance, the wiring can be traced, a diagram drawn and compared to many references in antenna books or handbooks. Another method is to use an Antenna Analyzer connected to the input coax connector.

### Electrical diagram of the Balun

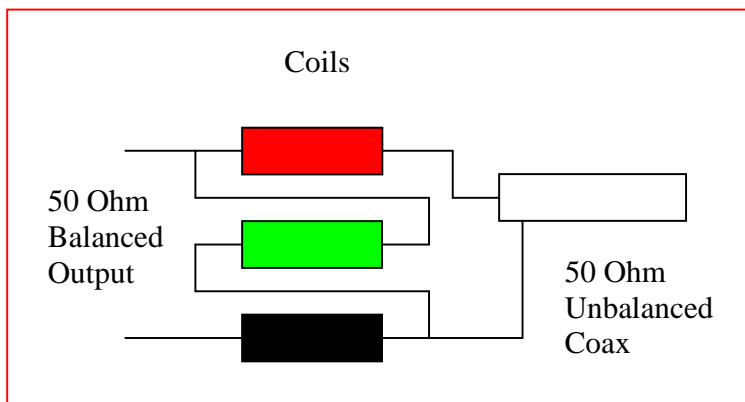

## BALUN IDENTIFICATION AND TESTING

First try a 47 or 51 ohm carbon resistor connected to the output terminals as shown. Set the frequency to 14 MHz since the beam is designed for 10-15-20 Meters. If the analyzer SWR reads around 1 to 1 then the output impedance is 50 ohms. The test frequencies are shown on the picture.

### Other Designs of Toroid or Rod Baluns

A 2 to 1 (100 ohm to 50 ohm) transformer needs a 100 ohm resistor. A 4 to 1 (200 ohm to 50 ohm) transformer needs a 200 ohm resistor (use 2 of 100 ohm resistors in series).

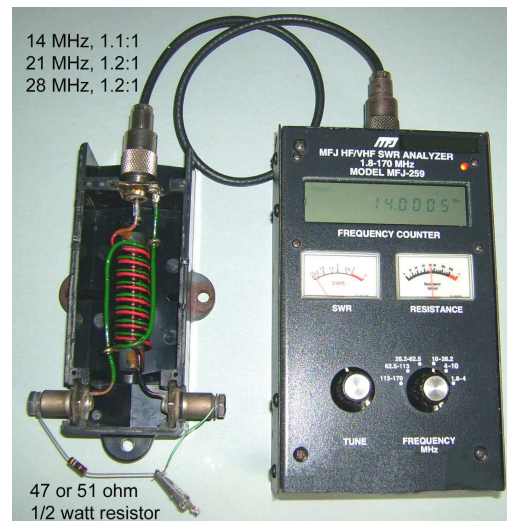

### SUMMARY

There may be other methods for cleaning and restoration of multi-band antennas. The methods in this article are illustrated to help amateur radio operators in maintaining their antennas in proper working order to eliminate unwanted radiated interference, protect equipment, and for mechanical safety. ....before the antenna is installed many feet above earth for years unknown.....

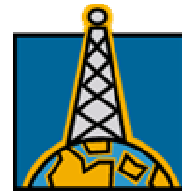

Hours & Cost depend on experience and degree of restoration. Estimate time to properly restore one trap is 2 hours. There are 12 traps on this mini-beam, therefore about 24 hours. Estimate time to clean the tubing and brackets is 10 to 20 hours. Replacement traps estimate \$35 to \$50. New hardware estimate is \$25 to \$50. Larger antennas take more time and cost.

### Alternate use of parts instead of complete restoration

To reduce time & cost, some of the traps can be restored and used to make different antenna designs. Accordingly, tubing length would also need modification. Examples: 10-15-20M trap dipole, 10-15-20M trap vertical dipole, or a ground mounted 10-15-20M trap vertical with buried radials.

Ideas for new portable or permanent antenna designs may be a good discussion at a club meeting. How about portable antennas or field day antennas using salvaged parts ?



**Thank you to Steve K8FZY for donating the mini-beam to make this article possible for the advancement of amateur radio knowledge. Thank You to Ralph K8HSQ for reviewing this article.**

**73, DE MIKE WA8MKH**

## Upcoming Fox Hunts

<u>Date</u>	<u>Start Time</u>	<u>Hunt/Talk-in Freq</u>	<u>Sponsor</u>	<u>Start Line</u>
May 2 <sup>nd</sup>	7:00 PM	147.525	Cuyahoga Falls ARC	2850 Church St, Stow, Ohio
<b>May 12<sup>th</sup></b>	<b>2:00 PM</b>	<b>147.525</b>	<b>Alliance ARC</b>	<b>1906 S. Union Ave, Alliance</b>
May 16 <sup>th</sup>	7:00 PM	147.525	Cuyahoga Falls ARC	2850 Church St, Stow, Ohio
May 30 <sup>th</sup>	7:00 PM	147.525	Cuyahoga Falls ARC	2850 Church St, Stow, Ohio

For changes, or additions, e-mail [kd8mq@arri.net](mailto:kd8mq@arri.net)

### April AARC Fox Hunt Results

The April 21st edition of the AARC fox hunt may have set a new record for cold temperatures in April, but a good time was had by all.

This months hunt was made tougher by the choice of hider. Ben, KD8MQ proved himself to be one devious son of gun. The fox was hidden at the Beechwood playground. It was nestled closely up against the chain link fence which surrounds one of the ball fields. One can only imagine the havoc this wreaked upon the transmitted signal.

First place was Jim, N8PXW, using his 3 antenna Doppler. Jim found the fox in a little over 10 minutes.

John, KD8MQ came in last place, only after several hunters tired of waiting for him to find the fox, and sent their GPS coordinates via both APRS, and SMS texting. ***Ya think they were trying to tell me something? :-)***

John promises that someday he will get his Doppler to actually work as designed.

The hunt got underway at about 2:15. The hunters, in order of finish were:

- Jim, N8PXW 2:26
- Tom, KC8QOD, and XYL Denise 2:27
- Ted, WD8CVH, Gay, WB8VNO, and Liz, KA8BNS 2:40
- Jeff, KD8QCF 2:51
- Don, K8OMO 3:06
- Ron, WC8F 3:16
- John, KD8MQ 3:27

The next AARC hunt will be on Saturday, May 12th. At the usual time.

This is a week earlier than usual, due to the Dayton Hamvention the following weekend.

In the meantime, feel free to check out other local hunts which are posted on [www.neofoxhunting.org/](http://www.neofoxhunting.org/) 73, and good hunting!

### Registration for the USA ARDF Championships are now open

Registration is now open for USA's twelfth annual championships of on-foot direction-finding, which will take place in the mountains east of San Diego, California on the first weekend of June, 2012.

There will be formal competitions on two meters and 80 meters, plus optional sprint and foxoring sessions. USA ARDF Championships are open to all. Visiting competitors from outside USA are welcome.

Competition winners may be invited to compete on Team USA at the ARDF World Championships in Serbia this September. Latest information is at

**[www.homingin.com](http://www.homingin.com)**



# Pioneer Amateur Radio Fellowship, Inc.

## Dayton Hamvention 2012

### Saturday, May 19, 2012 5:30 AM



Are the gas pumps keeping you from the Hamvention? Is the thought of driving down to Dayton and then parking your car in some shopping center to be then bused to the Hamvention keeping you from going? Why not take our bus to the Dayton Hamvention where you can come and go to the flea market with your great purchases and leave them on the bus. The bus will be parked close to the flea market entrance.

**You can save \$10\* if you book before April 24th.**

The cost of the **Bus & Entrance ticket** to the Hamvention:

**\$65\* before April 24, 2012**

The cost of the **Bus Only** to the Hamvention:

**\$50\* after April 24, 2012**

(You will need to get your own Hamvention Entrance Ticket at gate \$25, or order by phone & have held at Will Call--possibly getting Advanced \$20 price.)

We will take riders right up to departure that morning (if there are seats available) on a first come, first served basis.  
Departure time is 5:30 AM SHARP, so please be on time so you don't miss the bus!  
Parking will be in the back of the church.

There will be a stop for breakfast @ McDonald's and a dinner stop @ the Hometown Buffet (out of pocket expense).

Transportation is being provided by the Crossroads Transportation Company.  
This bus is a smoke free bus, so there will be no smoking permitted.

**To Order - Complete application & send with check/money order (*payable to "PARF"*) to:**

Joy Spencer [KA8TDF](mailto:KA8TDF)  
2101 Bigelow St  
Akron, OH 44314  
Or call 330-745-5115  
E-mail: [KA8TDF@arrl.net](mailto:KA8TDF@arrl.net)

**Please supply a return e-mail for your receipt confirmation.**

#### **Location of Departure is:**

Akron Baptist Temple  
2324 Manchester Road  
Akron, Ohio 44314  
Located on Rt. 93 just north of Rt. 224

Repeaters 147.135 & 146.610

***Please pass the word out to all of your ham friends & computer geeks.***

The above pricing does not include any tips...a hat will be passed for driver's tip.

## May 2012

Sunday	Monday	Tuesday	Wednesday	Thursday	Friday	Saturday																																											
<table border="1" style="margin: auto; background-color: #ffff00;"> <caption style="text-align: center;">Apr 2012</caption> <thead> <tr> <th>S</th><th>M</th><th>T</th><th>W</th><th>T</th><th>F</th><th>S</th> </tr> </thead> <tbody> <tr><td>1</td><td>2</td><td>3</td><td>4</td><td>5</td><td>6</td><td>7</td></tr> <tr><td>8</td><td>9</td><td>10</td><td>11</td><td>12</td><td>13</td><td>14</td></tr> <tr><td>15</td><td>16</td><td>17</td><td>18</td><td>19</td><td>20</td><td>21</td></tr> <tr><td>22</td><td>23</td><td>24</td><td>25</td><td>26</td><td>27</td><td>28</td></tr> <tr><td>29</td><td>30</td><td></td><td></td><td></td><td></td><td></td></tr> </tbody> </table>		S	M	T	W	T	F	S	1	2	3	4	5	6	7	8	9	10	11	12	13	14	15	16	17	18	19	20	21	22	23	24	25	26	27	28	29	30						<p><b>1</b></p> <p>7:00 PM Stark Cty ARES Net (147.12)</p> <p>9:00 PM Northern Columbiana Cty Training Net (147.255)</p>	<p><b>2</b></p> <p>Cuyahoga Falls FoxHunt</p>	<p><b>3</b></p> <p>7:00 PM PCARS Net (146.895)</p> <p><b>8:01 PM AARC CW (28.400 MHz)</b></p> <p><b>8:30 PM AARC SSB(28.400 MHz)</b></p> <p><b>9:00 PM AARC VHF (145.37(-))</b></p>	<p><b>4</b></p>	<p><b>5</b></p>	
S	M	T	W	T	F	S																																											
1	2	3	4	5	6	7																																											
8	9	10	11	12	13	14																																											
15	16	17	18	19	20	21																																											
22	23	24	25	26	27	28																																											
29	30																																																
<p><b>6</b></p>	<p><b>7</b></p>	<p><b>8</b></p> <p>7:00 PM Stark Cty ARES Net (147.12)</p> <p>9:00 PM Northern Columbiana Cty Training Net (147.255)</p>	<p><b>9</b></p> <p><b>AARC Meeting</b></p>	<p><b>10</b></p> <p>7:00 PM PCARS Net (146.895)</p> <p><b>8:01 PM AARC CW (28.400 MHz)</b></p> <p><b>8:30 PM AARC SSB(28.400 MHz)</b></p> <p><b>9:00 PM AARC VHF (145.37(-))</b></p>	<p><b>11</b></p> <p>8:00 PM Massillon Net (147.18)</p>	<p><b>12</b></p> <div style="border: 1px solid black; padding: 5px; width: fit-content; margin: auto;"> <p>2:00 PM AARC Foxhunt</p> <p>Tom, WA8VHH BD</p> </div>																																											
<p><b>13</b></p>	<p><b>14</b></p>	<p><b>15</b></p> <p>7:00 PM Stark Cty ARES Net (147.12)</p> <p>9:00 PM Northern Columbiana Cty Training Net (147.255)</p> <p>Charles, W8YNB BD</p>	<p><b>16</b></p> <p>Cuyahoga Falls FoxHunt</p>	<p><b>17</b></p> <p>7:00 PM PCARS Net (146.895)</p> <p><b>8:01 PM AARC CW (28.400 MHz)</b></p> <p><b>8:30 PM AARC SSB(28.400 MHz)</b></p> <p><b>9:00 PM AARC VHF (145.37(-))</b></p>	<p><b>18</b></p> <p>8:00 PM Massillon Net (147.18)</p>	<p><b>19</b></p>																																											
<p><b>20</b></p>	<p><b>21</b></p>	<p><b>22</b></p> <p>7:00 PM Stark Cty ARES Net (147.12)</p> <p>9:00 PM Northern Columbiana Cty Training Net (147.255)</p>	<p><b>23</b></p>	<p><b>24</b></p> <p>7:00 PM PCARS Net (146.895)</p> <p><b>8:01 PM AARC CW (28.400 MHz)</b></p> <p><b>8:30 PM AARC SSB(28.400 MHz)</b></p> <p><b>9:00 PM AARC VHF (145.37(-))</b></p>	<p><b>25</b></p> <p>8:00 PM Massillon Net (147.18)</p>	<p><b>26</b></p>																																											
<p><b>27</b></p>	<p><b>28</b></p>	<p><b>29</b></p> <p>7:00 PM Stark Cty ARES Net (147.12)</p> <p>8:00 PM Homeland Security Net (147.51)</p> <p>9:00 PM Northern Columbiana Cty Training Net (147.255)</p> <p>Jeff, KD8QCF BD</p>	<p><b>30</b></p> <p>Cuyahoga Falls FoxHunt</p>	<p><b>31</b></p> <p>7:00 PM PCARS Net (146.895)</p> <p><b>8:01 PM AARC CW (28.400 MHz)</b></p> <p><b>8:30 PM AARC SSB(28.400 MHz)</b></p> <p><b>9:00 PM AARC VHF (145.37(-))</b></p>	<table border="1" style="margin: auto; background-color: #ffff00;"> <caption style="text-align: center;">Jun 2012</caption> <thead> <tr> <th>S</th><th>M</th><th>T</th><th>W</th><th>T</th><th>F</th><th>S</th> </tr> </thead> <tbody> <tr><td></td><td></td><td></td><td></td><td></td><td>1</td><td>2</td></tr> <tr><td>3</td><td>4</td><td>5</td><td>6</td><td>7</td><td>8</td><td>9</td></tr> <tr><td>10</td><td>11</td><td>12</td><td>13</td><td>14</td><td>15</td><td>16</td></tr> <tr><td>17</td><td>18</td><td>19</td><td>20</td><td>21</td><td>22</td><td>23</td></tr> <tr><td>24</td><td>25</td><td>26</td><td>27</td><td>28</td><td>29</td><td>30</td></tr> </tbody> </table>		S	M	T	W	T	F	S						1	2	3	4	5	6	7	8	9	10	11	12	13	14	15	16	17	18	19	20	21	22	23	24	25	26	27	28	29	30	
S	M	T	W	T	F	S																																											
					1	2																																											
3	4	5	6	7	8	9																																											
10	11	12	13	14	15	16																																											
17	18	19	20	21	22	23																																											
24	25	26	27	28	29	30																																											

Alliance Amateur Radio Club  
 P.O. Box 3344  
 Alliance, OH 44601

## The AARC Wayback Machine

Here again are some of the highlights from the last 20 years of the Zero Beat. you can read them at <http://www.w8lky.org/newsltrs/>.

### **April, 1987 (Editor, KB8AKQ)**

- The first annual Mall Show (Hamvention) had just finished up.
- The speaker for the upcoming meeting was to be Ron, WC8F, speaking on another "Hamvention"; this one in the Dayton area.
- Larry, N8EWV was chosen as Ham of the Month, for organizing the Mall show.
- Dave, N8GHQ, and his family were moving back to west Virginia.
- At the most recent VE sessions, 7 people got their Novice licenses; 1 passed his Technician, and 2 passed their Extras.
- In a feeble attempt at humor, a article entitled "Novice Enhancement; One Step Beyond" was printed. It predicted a new novice

enhancement scheme where Novices would get full privileges, while Extras would be stripped of all privileges except for those formerly held by Novices. Additionally, all Novices would be inducted into the OO program.

### **May, 1987 (Editor, KB8AKQ)**

- Our Ham of the Month was Ron, KC8VG.
- We were trying to raise \$3000 to purchase the 145.37 repeater from Larry, N8EWV.
- We ran a story entitled "12 Ways to Destroy an Organization".

### **May, 1992 (Editor, KC3CL)**

- The FCC busted dozens of "freebanders"
- Incidences of Ham Radio fraud were found, during a sting by FCC personnel
- This was to be the last newsletter for Dave, KC3CL. Citing an ever more challenging work schedule, He found that he would be unable to

*(Continued on page 12)*